

BOB DILDINE

MEASUREMENT CONSIDERATIONS FOR NETWORK ANALYSIS AT MILLIMETER FREQUENCIES

Bob Dildine
Network Measurements Division
1400 Fountain Grove Parkway
Santa Rosa, CA 95401

RF & Microwave
Measurement
Symposium
and
Exhibition

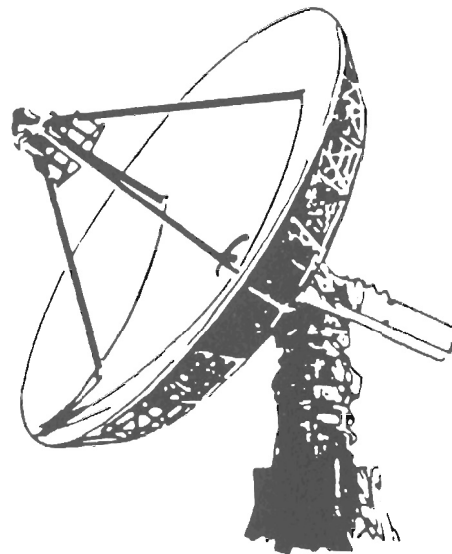

 HEWLETT
PACKARD

MEASUREMENT CONSIDERATIONS FOR NETWORK ANALYSIS AT MILLIMETER FREQUENCIES

This paper discusses the considerations for making accurate vector network measurements with the HP8510 in the waveguide bands between 26.5 GHz and 100 GHz. Methods of calibration, including one not requiring the use of a sliding load, types of calibration standards, flange repeatability, and other factors affecting system performance will be discussed. Measurement results for a variety of devices and calibration methods will be shown at frequencies up to 100 GHz.

Author: Bob Dildine, R&D Engineer, HP Network Measurements Division, Santa Rosa, Ca. BS Electrical Engineering (1967), San Diego State College and MS Electrical Engineering and Computer Science (1973), University of California, Berkeley. The author has been with HP since 1973. The majority of that time was spent as a member of a lab team developing the HP 8510 microwave network analyzer. Since 1980 he has been Project Manager for the HP 8511-8515 test sets for the HP 8510 and is currently involved with the extension of the HP 8510 to millimeter-wave frequencies.

**Measurement Considerations
For
Network Analysis
At
Millimeter Frequencies**

4361

**System Overview
Systematic Errors
Calibration
Non-correctable Errors
System Performance
Measurement Examples
Summary**

4362

System Overview

4363

This paper discusses methods for making accurate millimeter-wave vector network measurements with the HP 8510 Network Analyzer in the waveguide bands between 26.5 GHz and 100 GHz. Factors affecting system performance such as systematic and non-correctable errors, calibration methods, and flange performance will be discussed and measurement results for a variety of devices up to 100 GHz will be shown.

Features

- Vector Error Correction
- Time domain capability
- Accuracy and speed similar to microwave HP 8510 in stepped sweep operation
- Flexible test ports

4364

System Description

- Vector reflection/transmission system
- HP 8510 based system
- No HP 8510 series test set is used
- Full waveguide band coverage from 26 GHz to 100 GHz
- Complete description in product note 8510-1A

4365

SIMPLIFIED BLOCK DIAGRAM

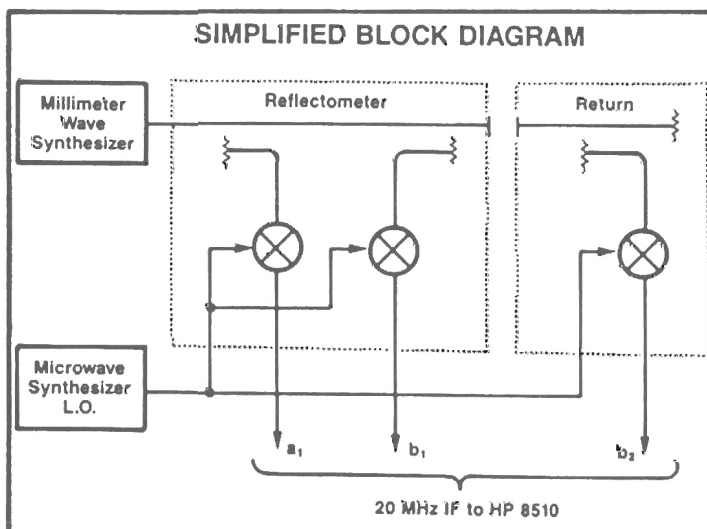

4366

The system that will be described allows most of the features of the HP 8510 to be used at millimeter-wave frequencies. Vector error correction and time domain are available. Due to the band-pass nature of waveguide, only the band-pass mode of time domain is available. And because of the dispersive nature of waveguide, the time representation is accurate, but the distance representation is not. However, useful information can be obtained from time domain. The millimeter system features accuracy and speed similar to that of the microwave HP 8510 in stepped sweep operation. In addition, the system has flexible waveguide test ports, eliminating the need for custom or flexible waveguide to connect the device under test.

The system is a reflection/transmission type of test set based on the HP 8510, but no HP 8510 series test set is used. Full waveguide band coverage is obtained from 26.5 GHz to 100 GHz, and the system is potentially extendible to any frequency band. A complete description of this system, along with operating considerations, is given in product note 8510-1A.

The system consists of a millimeter-wave synthesizer as the RF source and a microwave synthesizer as the system local oscillator. A reflectometer is made up of two waveguide directional couplers (a dual directional coupler could be used) with the coupled arms feeding two harmonic mixers. The harmonic mixers are driven from a common local oscillator and convert the incident and reflected signals directly to the 20 MHz IF of the HP 8510. The return port is made up of another directional coupler terminated with a fixed waveguide load. The coupled arm is fed to a third harmonic mixer driven from the same local oscillator as the other two mixers. In order to keep the IF signal coherent with the internal reference of the HP 8510, the time bases of the two synthesizers and the HP 8510 are all connected together. The HP 8510 and the two synthesizers are all controlled by an HP 9000 Series-200 or Series-300 computer.

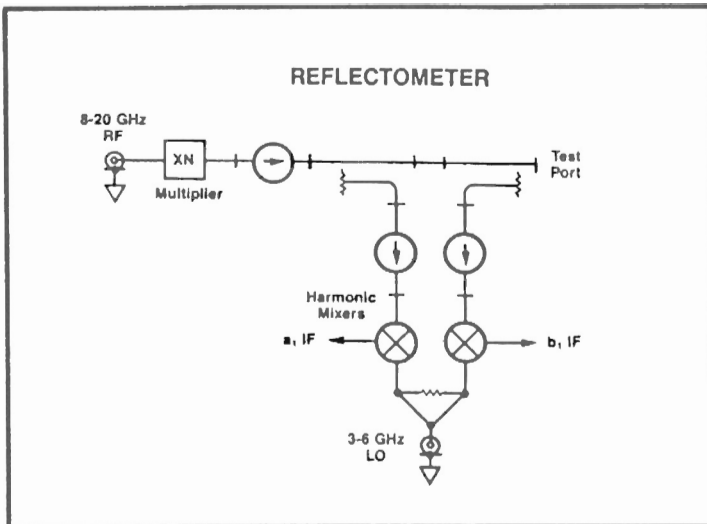

4367

This is a more detailed diagram of the reflectometer head showing the two directional couplers. In the system described in Product Note 8510-1A, the millimeter-wave synthesizer is made up of a microwave synthesizer driving a frequency multiplier. The output of the multiplier is fed to an isolator to improve the match looking back into the source and then fed to the directional couplers. The coupler outputs are also fed to isolators to prevent unwanted harmonics that are generated by the mixers from interfering with the measurement. The 3 - 6 GHz local oscillator is split by a power splitter and feeds both mixers. Although not shown here, 20 dB preamplifiers are used in the IF to overcome some of the mixer conversion loss and bring the IF signal level up to the optimum input range for the HP 8510.

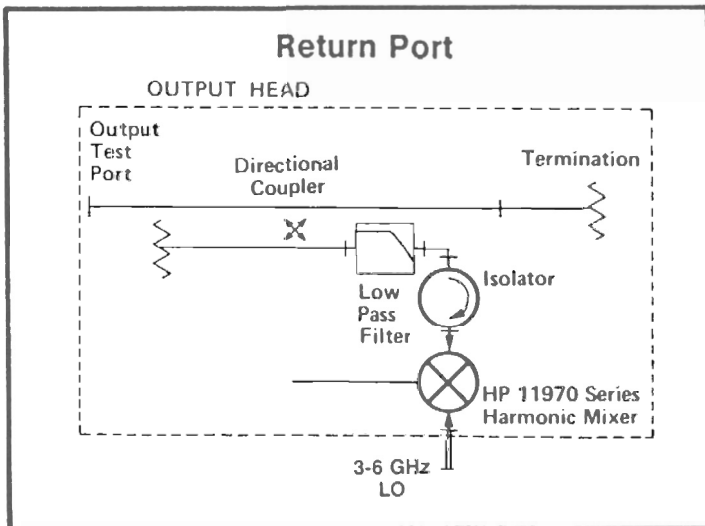

4368

The return port consists of a single directional coupler whose main arm is terminated by a fixed load and whose coupled arm feeds an isolator and harmonic mixer. A low-pass filter with a cutoff frequency just above the upper band edge can be used if desired and will help reduce the unwanted harmonics generated by the harmonic mixer. It has been found, however, that good performance can be obtained in the bands above 26 - 40 GHz without using the filter. As in the reflectometer head, a preamplifier is used in the IF to overcome some of the mixer conversion loss and bring the IF signal level up to the optimum input range for the HP 8510. The return port mixer LO uses a long .141-inch semi-rigid cable for flexibility. The assembly can be moved to allow insertion of the device under test.

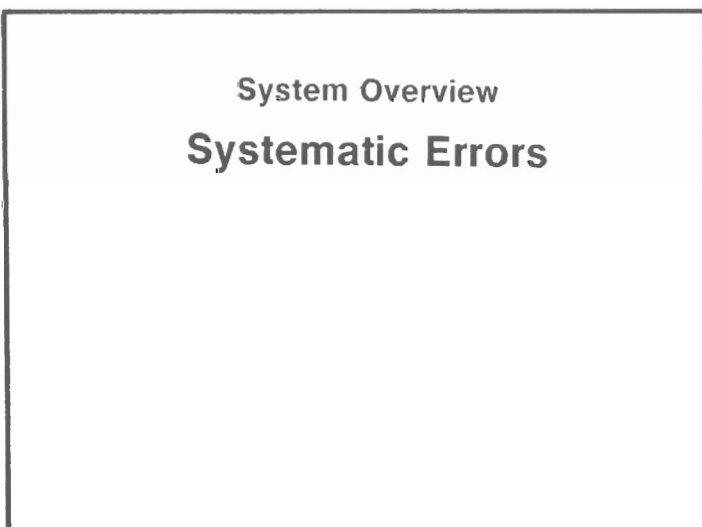

4369

Systematic Sources Of Error

- Frequency Response Tracking
- Directivity
- Source Match
- Load Match
- Isolation

4370

Frequency Response Tracking

- Variations in frequency response between test and reference signal paths
- Affects both transmission and reflection measurements

4371

Directivity

- Inability to absolutely separate incident and reflected waves
- Contribution of uncertainty depends on device
- Major error in reflection measurements, especially those with low reflection coefficients

4372

Systematic errors are errors in the measurement system that repeat from measurement to measurement and are independent of time and of the device being measured. Because these errors repeat, they can be measured and their effects removed from the measurement of the device. The systematic errors most encountered in network analysis are frequency response tracking, directivity, source match, load match, and isolation. Other errors such as connection repeatability, noise, compression, and the effects of spurious signals are not repeatable and cannot be corrected for.

Frequency response tracking errors are due to the differences in frequency response between the test and reference signal paths. These differences are usually due to the different components in the signal paths and affect both transmission and reflection measurements.

Directivity is the inability of the directional device in the reflectometer to absolutely separate the incident and reflected waves. For example, the directivity of a directional coupler may only be 30 or 35 dB. This means that the coupled arm still transmits a small amount of the energy traveling in the reverse direction, the amount being 30 or 35 dB lower than the energy traveling in the forward direction.

The contribution of directivity to the uncertainty of the measurement depends on the device and shows up most in reflection measurements, especially on devices with low reflection coefficients.

Source Match

- Mismatch between test port and system impedance
- Contribution of uncertainty depends on test device input impedance
- Major error when measuring devices with high input reflection coefficient

4373

Load Match

- Mismatch between return port and system impedance
- Contribution of uncertainty depends on test device output impedance
- Major error when measuring devices with high output reflection coefficient and/or low transmission loss

4374

Isolation

- Leakage between test and reference signals through the test set
- Major error when measuring devices with high transmission loss

4375

Source match is the mismatch between the test-port impedance and the system impedance. If the test-port impedance is not exactly equal to the system impedance, reflections from the test port can be re-reflected by the device under test and introduce errors into the measurement.

The contribution of source match to the uncertainty of the measurement depends on the device and shows up most in reflection measurements, especially on devices with high reflection coefficients.

Load match is the mismatch between the return port impedance and the system impedance. If the return port impedance is not exactly equal to the system impedance, reflections from the return port can be re-reflected by the device under test and introduce errors into the measurement.

The contribution of load match to the uncertainty of the measurement depends on the device and shows up most when measuring two-port devices with high output reflection coefficients and/or low transmission loss.

Isolation is the leakage between the test and reference signals through the test set. This leakage is usually due to cross talk between the test and reference paths in the test set or network analyzer.

The contribution of isolation to the uncertainty of the measurement may depend on the device under test and shows up most when making transmission measurements on devices with high transmission loss.

System Overview
Systematic Errors
Calibration

4376

Types of Calibration

- **Frequency response**
- **One-Port**
- **One-Path Two-Port**

4377

Frequency Response

- **Corrects for frequency response tracking**
- **Assumes perfect directivity and source match**
- **Useful for well matched devices**
- **Nothing more than a vector normalization**

4378

There are several types of calibration techniques that can be used to measure and account for the errors just discussed. Different techniques can be used depending on the accuracy desired. The techniques that account for the most errors require the most measurements and there is often a trade-off of effort for results. The three calibration techniques that are used in the millimeter system are Frequency Response, One-port, and One-path Two-port. Each of these will be discussed in detail.

Frequency response calibration only corrects for the frequency response tracking errors of the system. It assumes perfect directivity and perfect source match and is useful for measuring well-matched devices and for just taking a quick look at almost any device. The frequency response calibration technique is nothing more than a vector normalization.

One-Port Calibration

- **Corrects for:**
 - Directivity
 - Source Match
 - Reflection Frequency response
- **Useful for high accuracy reflection measurements of one-port devices**

4379

The one-port calibration corrects for directivity, source match, and frequency response. This technique is useful for making high-accuracy reflection measurements on one-port devices.

One-Path Two-Port

- **Corrects for:**
 - Directivity
 - Source match
 - Reflection frequency response
 - Load match
 - Transmission frequency response
 - Isolation

4380

The one-path two-port calibration corrects for directivity, source match, load match, transmission frequency response, reflection frequency response, and isolation.

One-Path Two-Port

- **Useful for measuring two port devices with high reflection coefficients on each port**
- **Provides best accuracy for any two port device using reflection/transmission system**
- **Must manually reverse the device**

4381

The one-path two-port technique is useful for measuring two-port devices with high reflection coefficients on each port and provides the best accuracy for any two-port device when using a reflection/transmission type test set. This technique requires that all four S-parameters be measured before the correction can be applied even if only one S-parameter is all that is needed. Because this system uses a reflection/transmission type test set, it is necessary to manually reverse the device under test.

Calibration Methods

- One-port
 - Reflection frequency response
 - Sliding load
 - Short line
- Two-port
 - Transmission frequency response
 - One-path two-port

4382

ONE-PORT ERROR MODEL

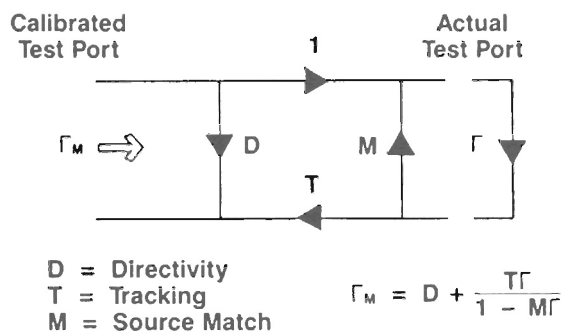

4383

Sliding Load Method

- One port calibration
- Corrects for
 - Directivity
 - Source match
 - Tracking
- Requires
 - Sliding load
 - Flush short
 - Offset short

4385

There are several different methods of performing calibrations for both one-port and two-port device measurements.

For measuring one-port devices, a frequency response calibration, sliding-load calibration, or a short-line calibration may be used. The frequency response calibration is the simplest and quickest method, but for more accurate measurements, it may be desirable to use a one-port calibration, either the sliding-load method or the short-line method.

Two port measurements may be made with either a simple transmission frequency response calibration or a one-path two-port calibration.

This is a flow diagram of the one-port error model showing the effects of directivity, source match, and frequency response tracking. Applying simple flow graph analysis techniques, we see that the measured reflection coefficient is a function of the actual reflection coefficient and the three error terms. If these error terms are known, the actual reflection coefficient can be calculated from the measured reflection coefficient and the error terms.

The sliding-load method uses a sliding load, short, and offset short to determine the three error terms, directivity, source match, and frequency response tracking. This is done by setting up three independent measurement conditions and then solving for the error terms. The directivity term can be determined by measuring a perfect load (reflection coefficient equal to zero); however, a perfect load is difficult to build. A perfect load can be simulated by a reasonably good load that can be moved in position within a good quality air line. This has the effect of rotating a small vector representing the imperfect load element around the directivity vector. By using circle fitting techniques, the center of the rotating vector and thus the directivity vector is found.

Reflection frequency response tracking and source match are found by measuring two other known standards and solving two simultaneous equations for these error terms. A flush short is an easy standard to fabricate and combining this with a quarter-wave section of precision waveguide gives a second known standard. The waveguide does not have to be exactly a quarter wave long, but using its actual measured length will result in improved accuracy.

Short Line Method

- One-port calibration
- Corrects for
 - Directivity
 - Source match
 - Frequency response tracking
- Requires
 - Flush short
 - Fixed load
 - 1/4 wave delay

4386

At higher frequencies, the waveguide dimensions become so small that it becomes very difficult to manufacture a sliding load with the required precision to use as a calibration standard. An alternate method is the short-line method which requires only a fixed load with good repeatability, a flush short, and a quarter-wave offset short.

Like the sliding-load method, the short-line method corrects for directivity, source match, and frequency response tracking.

The short-line method measures four independent conditions, and solves four simultaneous equations for the four unknowns: directivity, source match, frequency response tracking, and the reflection coefficient of the load used for calibration.

The four standards that are measured are a fixed load, the fixed load offset by a delay, a flush short, and a short offset by a delay. The same delay can be used for offsetting both the load and the short, minimizing the number of components in the calibration kit. This delay is made from a waveguide shim about a quarter wave thick at mid-band. For best accuracy, the shim's physical length should be accurately measured, and this value entered into the calibration routine.

A flush and quarter-wave offset short is used rather than the more traditional one piece 1/8- and 3/8-wave offset shorts because of ease of fabrication.

Calibration Standards

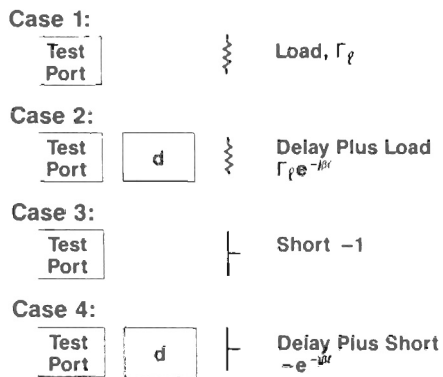

4388

Short Line Procedure

- Measure each case
- Four equations in four unknowns, D , T , M , Γ_L
- Solve for
 - Directivity, D
 - Tracking, T
 - Source match, M
 - Load, Γ_L

4389

The short-line calibration procedure is to measure each standard, creating four independent simultaneous equations for the error terms and value of the load, and solve for each unknown.

Short Line Assumptions

- Delay is lossless perfect waveguide with known length (loss can be accounted for if desired)
- Uncorrected directivity, source match, and fixed load are pretty good (<35 dB)

4390

In order to simplify the math involved in solving the four simultaneous equations, several assumptions have been made for the short-line calibration method. The delay must be perfect waveguide whose electrical parameters can be calculated from its physical dimensions (loss can be accounted for if desired). In addition, it is assumed that the uncorrected directivity and source match are reasonably good and that the fixed load is of reasonably good quality. Errors in the calibration results are on the order of the third-order products of these terms so if directivity, source match, and the fixed load are all 35 dB or greater, the errors due to the assumptions will be greater than 105 dB down.

Two-Port Forward Flow Graph

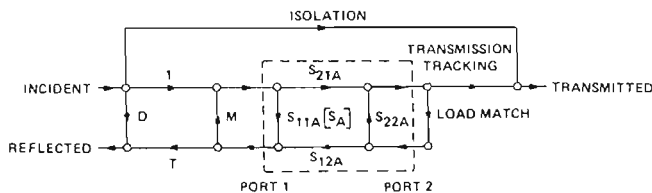

4391

This is a flow graph of a two-port measurement with a reflection/transmission test set. Three more error terms: isolation, load match, and transmission frequency response tracking account for the errors in the transmission measurement.

One-Path Two-Port Calibration

- Calibrate port 1
- Connect test ports
- Measure tracking and load match
- Disconnect test ports, terminate each port
- Measure isolation

4392

The one-path two-port calibration method measures and accounts for these additional errors.

Port 1 is calibrated using one of the previously described one-port calibration methods. The ports are connected together (with no interconnection length) and tracking and load match are measured. The ports are then disconnected and terminated, and isolation is measured.

Quality of Calibration Standards

- Sliding load
 - Accurate waveguide
 - Load element reasonable return loss
 - No discontinuities
 - Good slide stability
 - Good flange repeatability
- Fixed load
 - Load element reasonable return loss
 - Good flange repeatability

4393

Quality of Calibration Standards

- Flush short
 - Lossless
 - Repeatable
 - Flush (ie length = 0)
- Shim
 - Lossless
 - Known length
 - Perfect waveguide - or must be calculable

4394

Calibration

How much is really necessary?

5028

Ideally, the standards used to calibrate the system should be perfect, but practical manufacturing techniques preclude this. The important features of a good standards-quality sliding load are that it is made with accurate waveguide, the load element have a reasonable return loss (35 dB or more), there are no discontinuities as a result of fixed reflections, the load element is stable as it slides in the waveguide, and the flange connections are repeatable.

A fixed load of good standards quality must have good flange connection repeatability and reasonably good return loss. For the short-line method, the return loss only has to be 35 dB or so, but to be used as a stand-alone fixed load, it should be as good as possible. In addition to being repeatable, the flanges must also have low loss.

The flush short used for calibration must be as flat as possible so that it makes a lossless connection to the waveguide. It must also be repeatable, and truly flush with no length. A surface that is lapped to a smooth finish and plated with a good conductor such as gold makes an excellent short.

The quarter-wave shim used for calibration must be of known length, and make repeatable connections. It is desirable for the shim to be lossless, but loss can be accounted for if necessary. Rather than try to hold unreasonable tolerances on the shim length in the manufacturing process, the length of the shim should be measured and the actual length used in the calibration routines. The dimensions of the waveguide aperture must be either perfect or they must be such that the electrical parameters of the waveguide can be calculated.

We have seen that there are several different ways to calibrate the system depending on how much time we want to take and what accuracy we want for our measurement. The questions are, "How much calibration is really necessary for the task at hand? What are the trade-offs, for example, between a quick frequency response calibration and a full one-path two-port calibration?" The following examples will try to answer these questions.

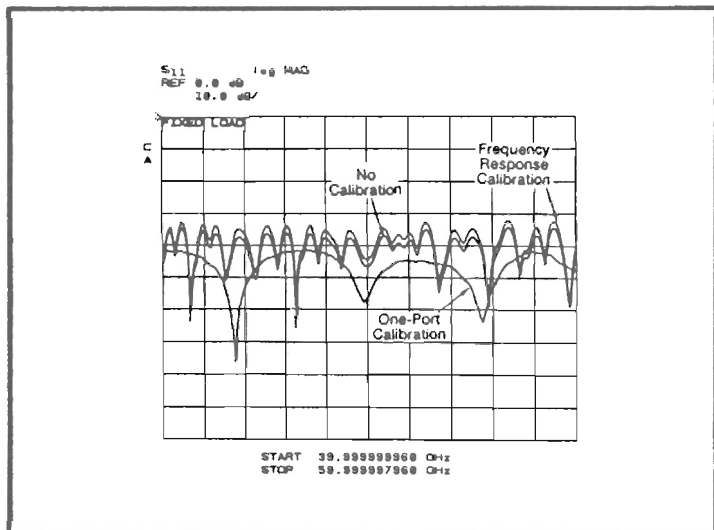

5029

This is an example of a fixed waveguide load measured with three different calibrations. Notice that the measurements with no calibration and frequency response calibration are identical except for a slight offset which is due to the frequency response error. The one-port calibration corrects for directivity and source match in addition to frequency response calibration. Notice the relatively smooth response of the load whereas the measurements that are not corrected for directivity show a beat pattern between the directivity error term and the load element.

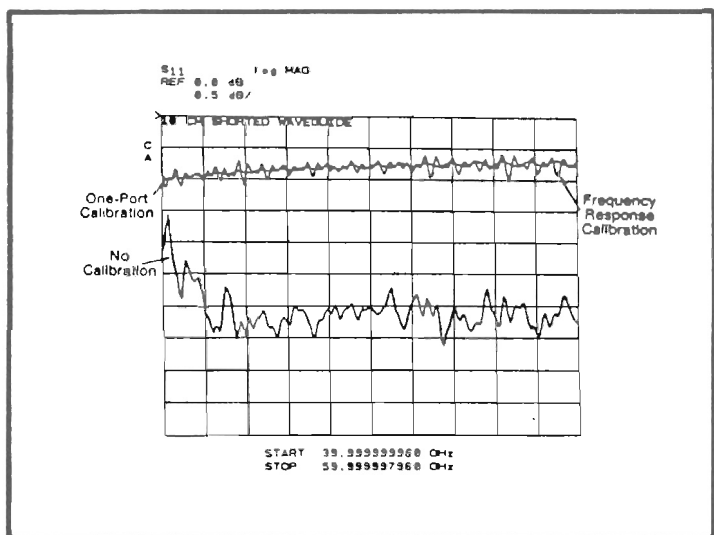

5030

This is a measurement of a high-reflection device (a 10-cm section of waveguide with a short at the far end). Notice the considerable error due to frequency response. Note also the beat between the uncorrected directivity, uncorrected source match, and the shorted waveguide in the measurement made with frequency response calibration. The data taken with full one-port error correction still shows the effects of residual directivity and source match (the errors left after correction) beating with the shorted waveguide. This illustrates that not all of the errors are completely removed by calibration.

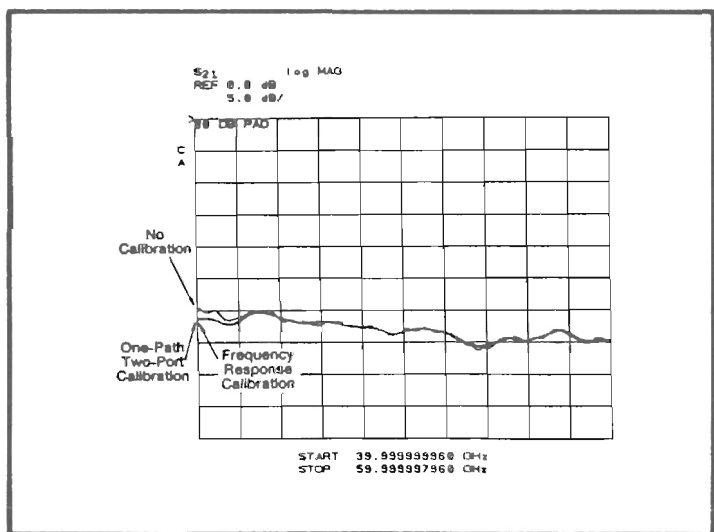

5031

This is a measurement of a 30 dB waveguide attenuator and is an example of a lossy two-port network with good match at each port. Note that the measurement results with the frequency response calibration are virtually identical to those with the full two-port calibration for this type of device. Thus the same information was obtained with two measurements (one for a frequency response calibration and one for measuring the device) as was obtained with seven measurements (five for one-path two-port calibration and two for the measurement - remember all four S-parameters must be measured and the device must be turned around). Even with no calibration, the accuracy is probably sufficient for a quick look at a device.

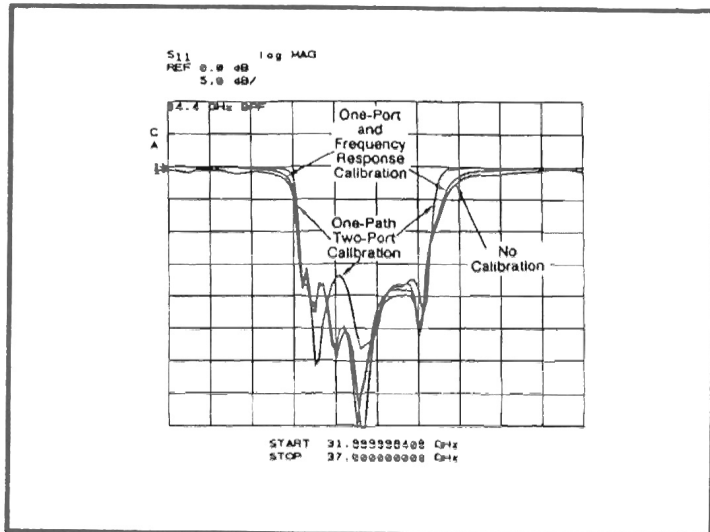

5032

This is a filter measurement and illustrates the case of a device that has both high reflection (filter stopband) and low transmission loss (filter passband). At the cutoff frequencies, the filter has both relatively high reflection and low transmission loss simultaneously. In this example of the reflection coefficient measurement, note that with no calibration the frequency response error clearly shows. Frequency response calibration and one-port calibration agree quite closely in the stopband, on the filter skirts, and throughout most of the passband, leading one to suspect that a frequency response calibration might be sufficient. Note however that the one-path two-port calibration yielded significantly different results on the filter skirts and in the passband. The passband corners are clearly defined and the passband ripple is fairly well behaved, showing the effects of removing the load match error contribution from the measurement.

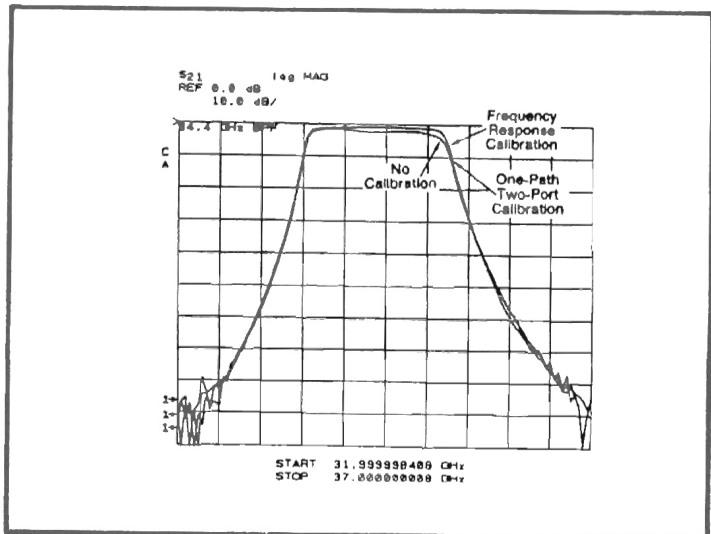

5033

The transmission response of the same filter shows the difference between no calibration, frequency response calibration, and full one-path two-port calibration. With no calibration, the frequency response error shows clearly. The data taken with frequency response calibration and full one-path two-port calibration are identical and the traces coincide. The load match and isolation of this system are sufficiently good that they do not introduce significant errors in the transmission measurements of the filter.

One Port Devices

Device	Major Error	Advised Cal
• Low refl	Directivity	One-port
• High refl	Source Match Directivity	One-port

5034

We have seen that for one-port devices that are reasonably well matched, the uncorrected directivity is the major error in the measurement. For one-port devices with high reflection coefficients, both the uncorrected directivity and source match are major errors in the measurements. Therefore the additional effort of a one-port calibration is well worth while when measuring one-port devices.

Two-Port Devices		
Device	Major Error	Advised Cal
• Low refl high loss		
- S ₁₁	Directivity	One-Port
- S ₂₁	Isolation	Response
• Low refl low loss		
- S ₁₁	Directivity Load Match	Two-port
- S ₂₁	Tracking	Response

5035

Reflective Filters		
Device	Major Error	Advised Cal
• Passband		
- S ₁₁	Directivity Load match	Two-Port
- S ₂₁	Tracking	Response
• Stopband		
- S ₁₁	Source match	One-port
- S ₂₁	Isolation	Response

5036

Reflective Filters		
Device	Major Error	Advised Cal
• Corner		
- S ₁₁	Directivity Load match	Two-Port
- S ₂₁	Tracking	Response

5037

When making measurements of two-port devices, it is not always necessary to make a full one-path two-port calibration. We saw that for low-reflection, high-loss devices such as attenuators, a one-port calibration is usually sufficient for S_{11} measurements. Although isolation is the major error affecting high-loss devices, the isolation in this system is sufficiently good that excellent measurements can be made with only a frequency response calibration. Likewise, the source and load match in this system are good enough that for well-matched, two-port devices, they do not contribute to the measurement uncertainty.

For low-reflection, low-loss devices, the system's directivity and load match contribute significant errors for S_{11} measurements, and it is recommended that a one-path two-port calibration be used. Again, the source and load match are good enough that they do not seriously affect S_{21} measurements, and a frequency response calibration is sufficient for a good measurement; however, if the utmost in accuracy is required, the one-path two-port calibration can be used.

For reflective filters and other devices that have both low transmission loss and high reflection coefficients, the calibration depends on the measurement being made. A frequency response calibration is sufficient for good S_{21} measurements, while a one-port calibration is recommended for measuring S_{11} in the stopband and a one-path two-port calibration is recommended for measuring S_{11} in the passband.

At the corner frequencies of a reflective filter, the device is simultaneously reflective and relatively low loss. When making S_{11} measurements, the major errors are due to both directivity and source match as in the general case for low loss devices and a full one-path two-port calibration is recommended. The source and load match of the system are sufficiently good that for S_{21} measurements, all that is required is a frequency response calibration.

System Overview
Systematic Errors
Calibration
Non-correctable Errors

5038

Non-correctable Errors

- Noise
- Spurious responses
- Cable repeatability
- Connection repeatability
- Drift
- These errors cannot be removed by calibration

5039

Non-correctable errors are those errors that are not repeatable over time or from device to device and therefore cannot be measured and subtracted from future measurements. Examples of non-correctable errors are noise, spurious responses, changes in magnitude or phase due to cables flexing within the system, and connection repeatability.

Trace noise

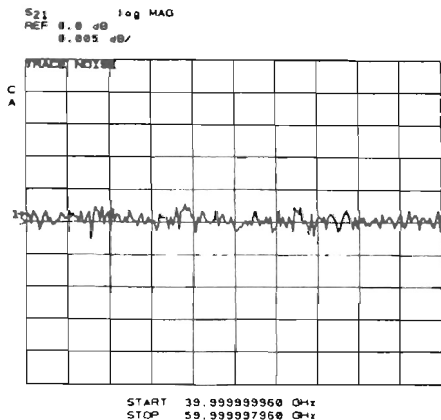

4396

This is an example of trace noise which is typically a few thousandths of a dB. The trace noise increases to approximately .01 dB in the 75 to 100 GHz band. The averaging factor for this measurement was 64.

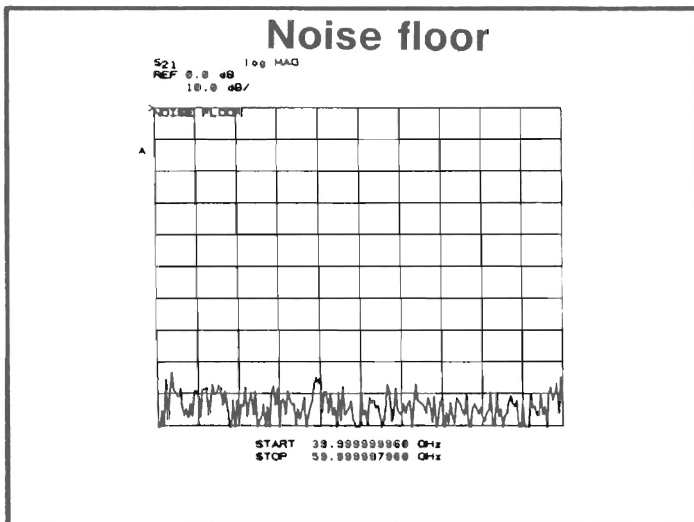

5040

This is an example of the system noise floor in the 40 to 60 GHz band. The noise floor ranges from approximately -95 dB with respect to a thru connection in the 26.5 to 40 GHz band to approximately -75 dB in the 75 to 100 GHz band. Note that this measurement as well as the previous one was made with an averaging factor of 64 which essentially comes for free in this system because the HP 8510 can take 64 measurements while the rest of the system is getting ready to move on to the next measurement point. Increasing the averaging factor will lower the noise an amount equal to the square root of the averaging factor. In other words, using an averaging factor of 1024 will cause the noise to decrease by a factor of 4 or 12 dB ($1024/64 = 16$; square root of 16 = 4 or 12 dB).

Spurs

- Caused by harmonic mixers acting as harmonic generators
- Degrade dynamic range when measuring highly reflective devices

4398

Harmonic mixers are used in the system and these mixers act as harmonic generators as well as mixers. Energy from one mixer can be fed to the other mixers via the device under test or directly through the system waveguide connections. These out-of-band signals may go through the passband of a filter while we are measuring the stopband. A mechanism exists to create an unwanted 20 MHz IF because of this. The result is reduced dynamic range, especially with highly reflective devices such as filters in their stopband. Isolators are used in front of each mixer to increase the path loss for signals generated by the mixers and in the 26.5 to 40 GHz band, a low-pass filter is used in addition to the isolator in the return mixer to reject out-of-band signals that are generated by the mixer.

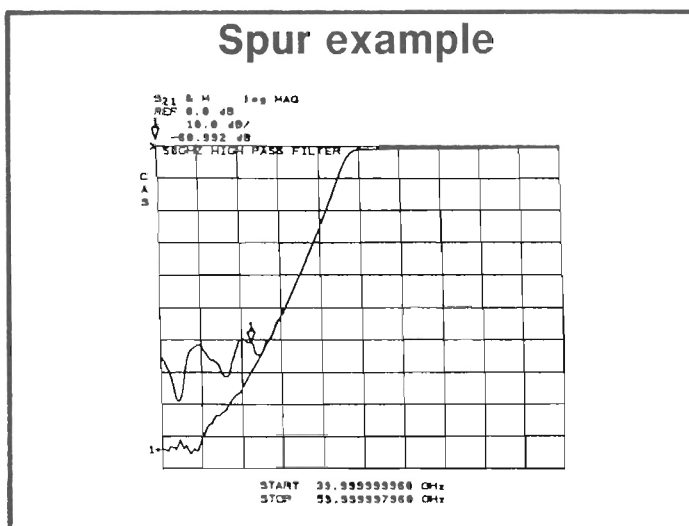

3688

This is an example of the reduction in dynamic range that could happen if the mixer spurs are not dealt with effectively. The upper trace in the filter stopband is due to mixer spurs in a system without the necessary isolators in front of the mixers. Note that the dynamic range is increased by approximately 30 dB by adding isolators to the system.

Flange Repeatability

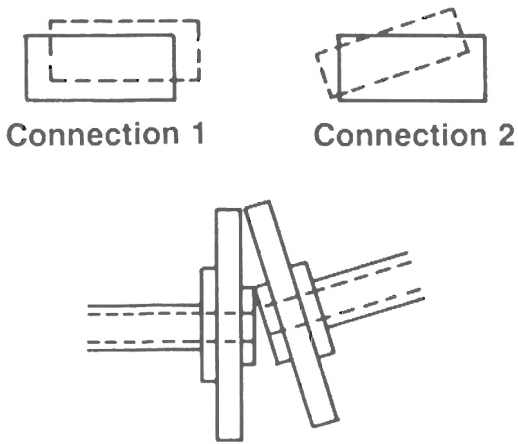

4400

Flange connection repeatability and cable repeatability are major contributions to error after calibration. Each time the flange is connected, the waveguide apertures can be slightly misaligned from the previous connection. The "Mil-Spec" flanges can be cocked due to the flange screws being outside of the center boss if care is not taken in making the connection. In addition, the contact impedance between the flanges varies from connection to connection.

HP Precision Flange

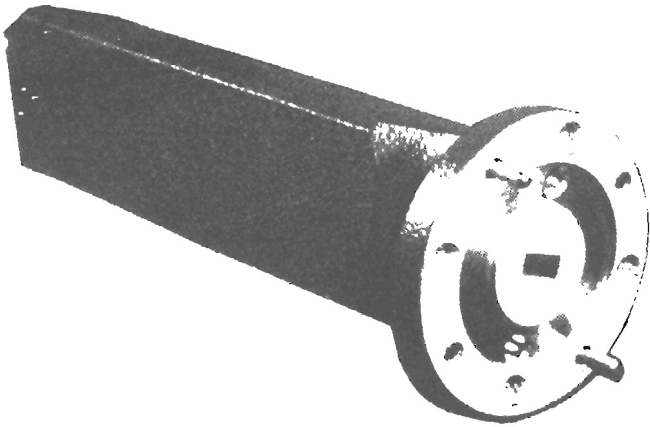

4401

The possible misalignment of the waveguide apertures can be minimized by tightening the tolerances of the alignment pin locations and the pin diameters. In addition, adding two precision locating pins allows even more precise alignment of the waveguide apertures. Adding a lip around the perimeter of the flange in the screw ring while setting the lip back from the center boss slightly eliminates the possibility of cocking the flanges.

Shown here is a photograph of the Hewlett-Packard precision flange that incorporates all these features.

Flange repeatability

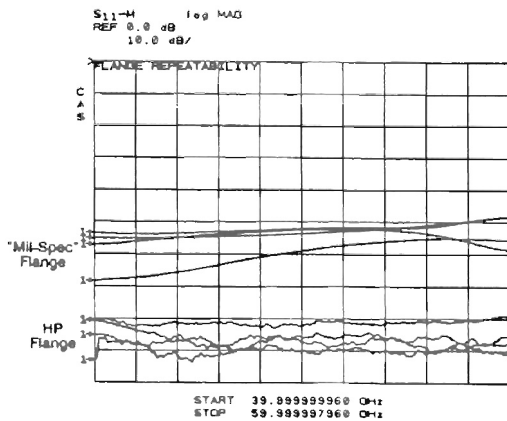

4403

This is an illustration of flange repeatability. The test was made by measuring a fixed load and storing the measurement into the display memory of the HP 8510. The flange was disconnected, reconnected, and measured again, subtracting the previous measurement using trace arithmetic. The process was repeated several times to show the effects of flange repeatability. The repeatability of the "Mil-Spec" flange is compared to the repeatability of the Hewlett-Packard precision flange. Care was taken in each case to make as careful a connection as possible. Note that the repeatability error for the Hewlett-Packard precision flange is on the order of 80 to 90 dB down, considerably less than the residual system errors after correction.

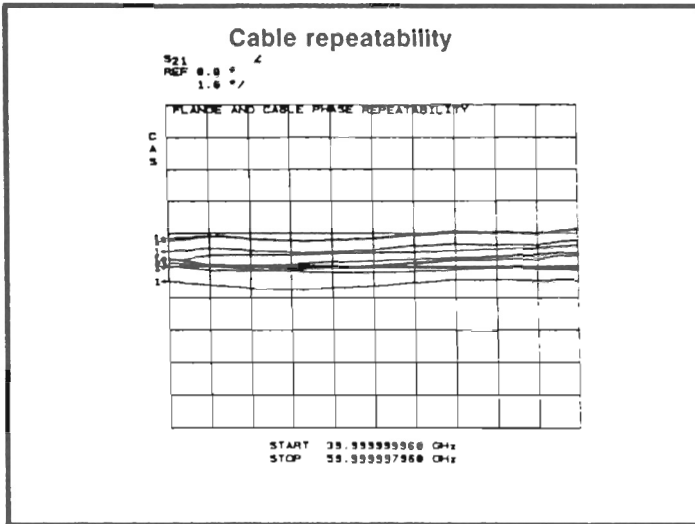

4399

The local oscillator cable to the transmission head is the most critical since it must be flexible. Cable phase stability is sensitive to movement and temperature. Cable phase also "creeps" for hours after major deformations. If the elastic limit is not exceeded, performance is much better. In this example, a simple frequency response calibration was used to measure insertion phase. The transmission head was then removed and the cable flexed to simulate the insertion of a device under test. The resulting change in phase is about +/-1 degree, corresponding to .1 degree phase stability at 4-6 GHz, the local oscillator frequency. If the cable were to undergo a severe deformation, the repeatability would be 3-5 degrees at millimeter-wave frequencies.

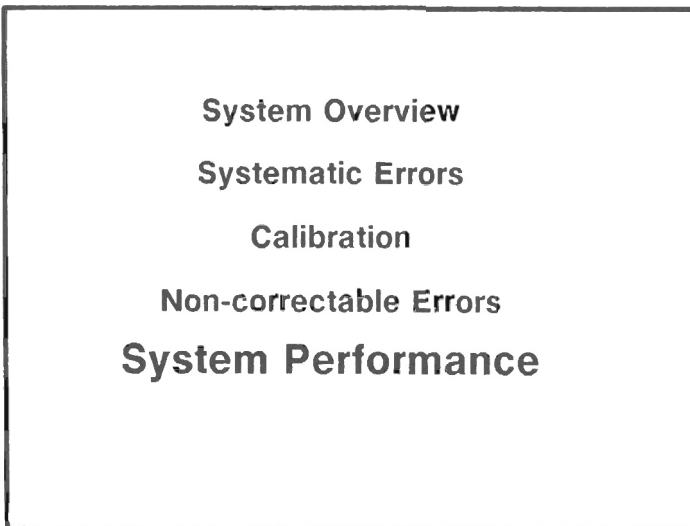

5040

System performance can be judged by the magnitudes of the errors after calibration. We will now discuss several techniques for measuring these errors and show some examples of system performance.

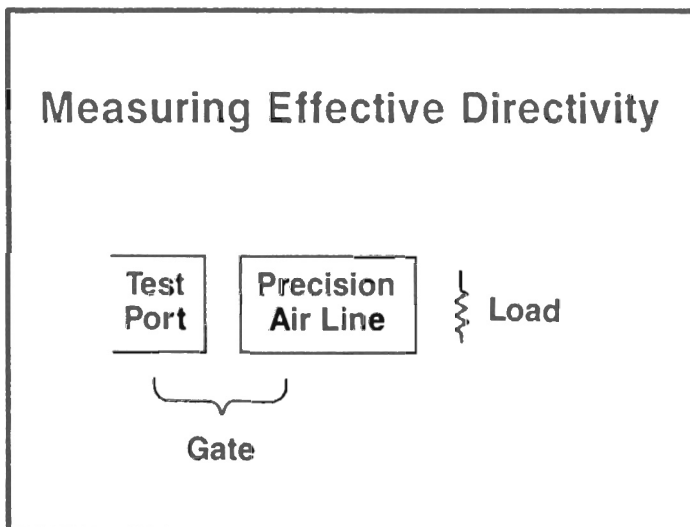

5041

Effective directivity is the directivity after error correction has been applied. It can be measured by applying a perfect load to the test port. If directivity is perfect, then the measured reflection coefficient will be zero. Otherwise, the measured reflection coefficient is due to effective directivity.

A precision air line (low-loss precision waveguide) and a reasonably good load can be used instead of a perfect load. Time domain gating is applied around the test port and the directivity vector which appears in time at the location of the test port is separated from the reflection of the load.

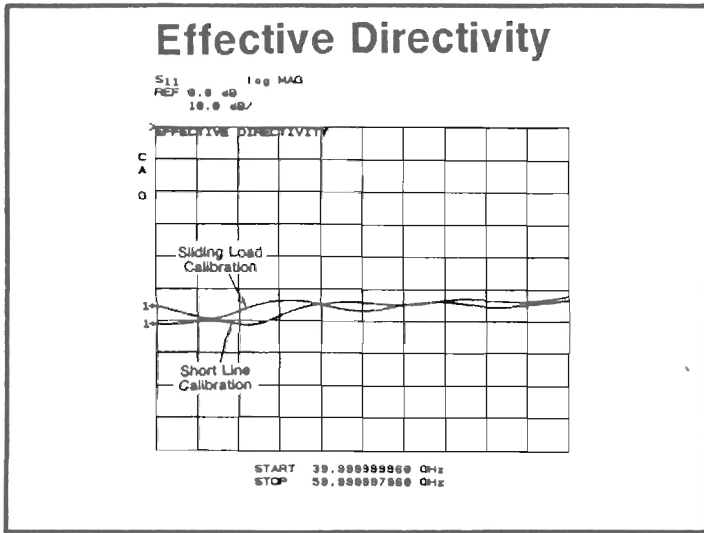

5042

This is an example of effective directivity measured with time domain gating applied around the test port. Note the two traces which compare the effects of the sliding-load calibration to the short-line calibration. Both calibrations have yielded an effective directivity of better than 50 dB.

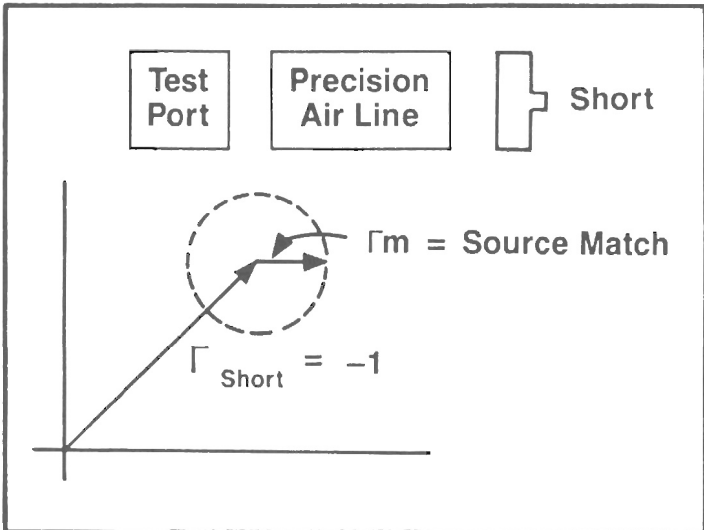

5043

Effective source match is measured by applying a precision air line terminated with a short to the test port. The short is a vector with a reflection coefficient of -1 and being displaced in distance (and time) from the test port has the effect of rotating this vector around the effective source match vector at the test port. If we make the vector due to the short our reference, then we can consider the effective source match vector to be rotating around it. In a similar manner, the effective directivity vector also rotates with the source match vector and must be accounted for. The reflection coefficient of the shorted air line is measured, giving a certain amount of ripple due to the beating of the effective source match and directivity with the short. The effective directivity has already been measured and its effect can be subtracted using trace math, leaving the beat due to effective source match and the short. From the amplitude of this beat, the effective source match is calculated.

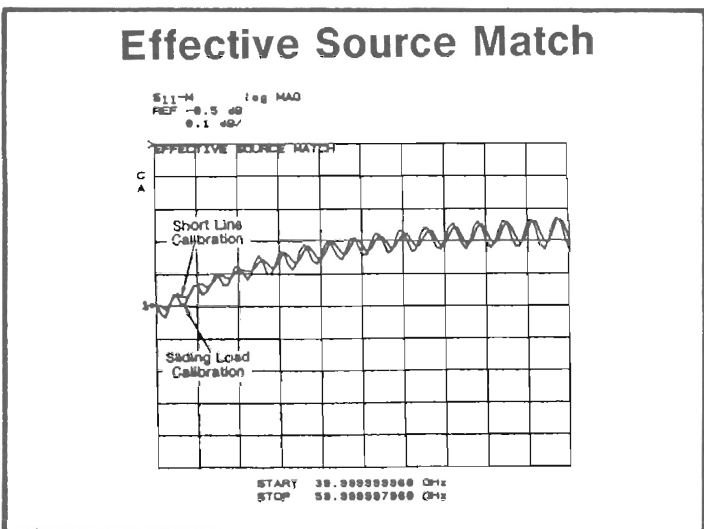

5044

This is an example of effective source match with effective directivity subtracted using trace math. Note the two traces which compare the effects of the sliding-load calibration to the short-line calibration and that they essentially coincide. Both calibrations have yielded an effective source match of better than 45 dB at the upper end of the band.

Effective Directivity and Source Match in Time Domain

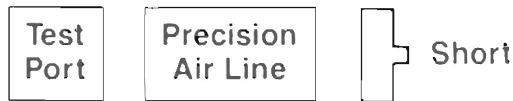

5045

Both effective directivity and effective source match can be observed directly using time domain. The effective directivity error term is a signal path that couples off the incident wave being sent out of the test port, and the source match error term is a reflection of energy back to the device under test from the test port. A short on the end of an air line can be used as a mirror to look back into the test port in time domain to evaluate the source match. In this case, we have used a 10-cm precision waveguide terminated with a short and measured in time domain.

Effective Directivity and Source Match

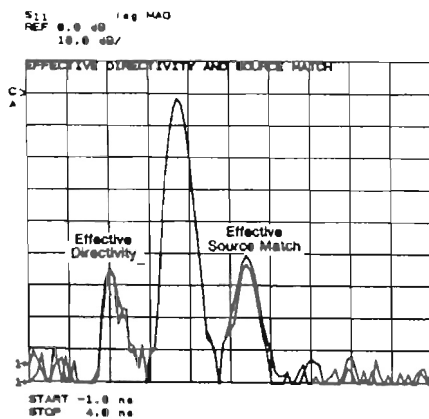

5046

This is the time domain display showing the effective directivity (the response at time zero, the second division), and the effective source match (the response at 1.7 nsec, between the fifth and sixth division). The large response between is the short. The height of the responses represents the average value over the frequency range measured and agrees quite closely with the values measured in the frequency domain. Again, the two traces are for the sliding-load calibration and the short-line calibration.

The accuracy of this technique is limited by the dispersion of the waveguide and is affected by the time domain parameters in use.

Measuring Other Residual Errors

- Tracking - Measure a precision air line and a short
- Load match - Measure a precision air line and gate around port 2
- Noise
 - Measure trace noise with thru
 - Measure noise floor with ports isolated
- Spurs and Dynamic range - Measure high pass filter

5047

The other residual errors are measured in straightforward ways. Residual transmission tracking error is evaluated by measuring a precision air line. Residual reflection tracking error is evaluated by measuring a shorted air line and using time domain and gating to examine only the response of the short. Time domain is used to measure load match by placing an air line between the ports to physically separate the directivity error from the load match and gating around port two to isolate the effective load match term.

Spurs and dynamic range can best be evaluated by measuring a filter. An excellent high-pass filter can be constructed very easily by using a standard waveguide straight for two bands higher than the one being measured and the appropriate adapters. The cutoff frequency of the higher frequency waveguide will be approximately in the center of the band of interest.

Residual Errors 40 - 60 GHz

- Tracking ± .1 dB
- Load match 40 dB
- Trace noise .01 dB P-P
- Noise floor - 80 dB
- Dynamic range - 85 dB

5048

Effective directivity and effective source match were shown in the preceding plots. These are some typical values for the other residual errors measured on this system in the 40 to 60 GHz band.

System Overview
Systematic Errors
Calibration
Non-correctable Errors
System Performance
Measurement Examples

5049

We will now take a look at measurements of some typical devices found at millimeter-wave frequencies.

WR-10 High Pass Filter

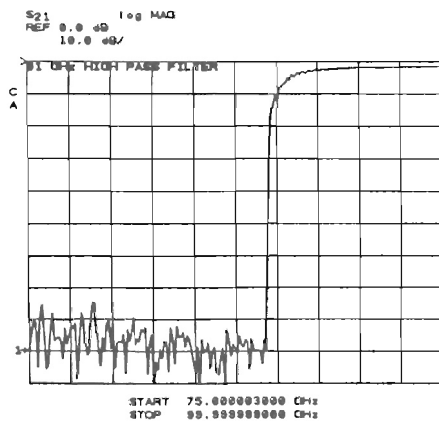

5050

This is a high-pass filter made from a 10-cm length of WR-7 (110 to 170 GHz) waveguide and adapters to WR-10 (75 to 110 GHz) waveguide.

Note the 75 dB-plus dynamic range that can be obtained at this frequency.

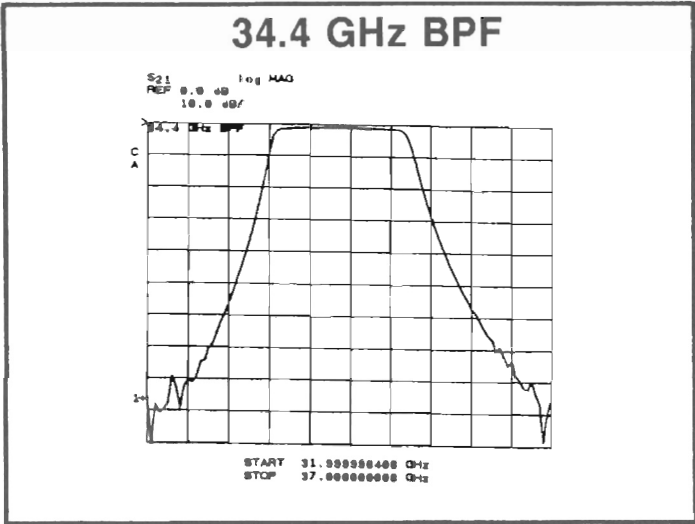

5051

This is the magnitude response of a band-pass filter centered on 34.4 GHz. The filter's passband and skirts are well defined and clearly visible down to about 85 dB.

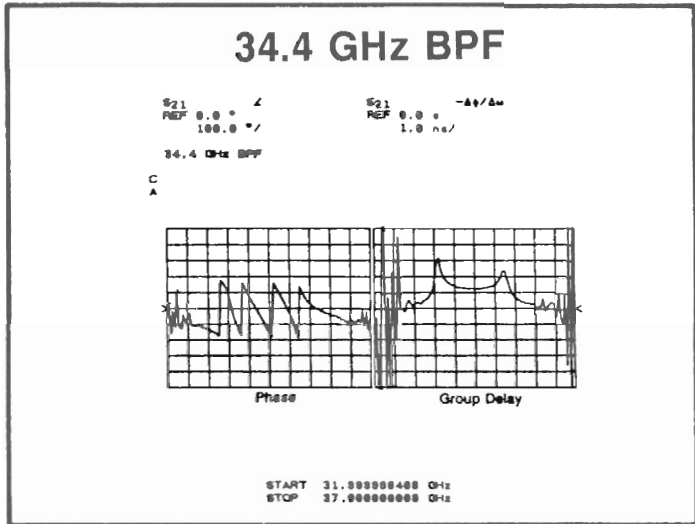

5052

Here is the phase and group delay response of the same filter.

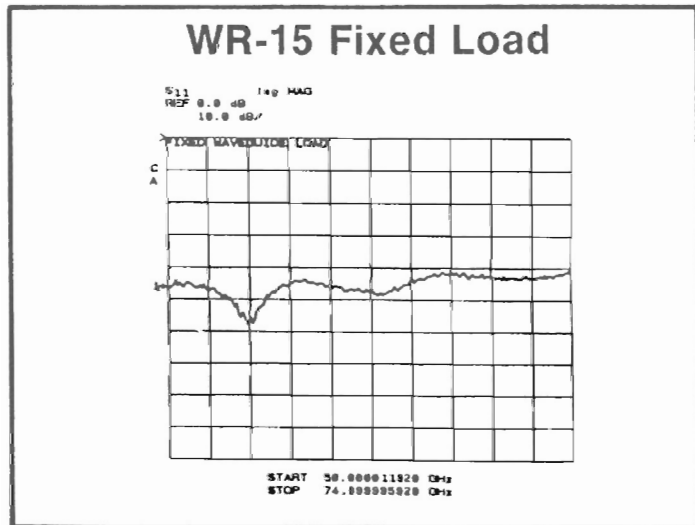

5053

This is the reflection coefficient of a fixed WR-15 waveguide load with a one-port short-line calibration.

Short and Offset Short

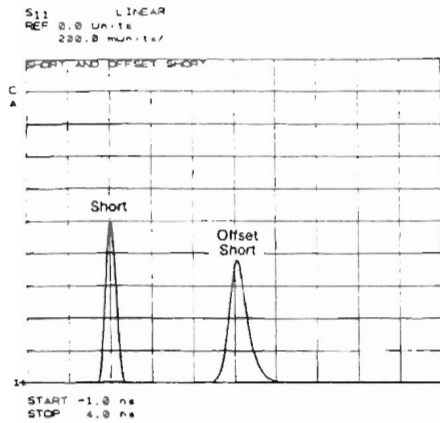

5054

The S_{11} band-pass response of a sliding short placed near the calibration plane is shown on the left side of the plot. Time domain band-pass responses in waveguide become smeared or spread out the farther that measurements are made from the calibration plane. This is evidenced by the rightmost response, the band-pass response of the same sliding short placed at the end of a section of waveguide. The time domain response is correct in waveguide, and the markers read the correct time, but the distance domain information is incorrect due to dispersion. Time domain in waveguide is most useful near the plane of calibration and can be misleading for long devices.

WAVEGUIDE TO COAX ADAPTER

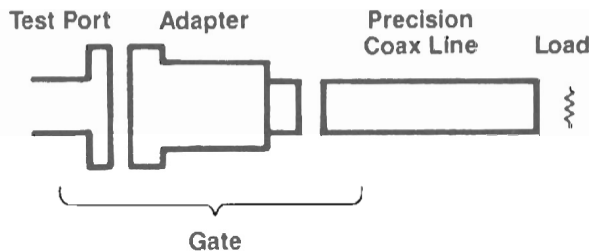

5055

The return loss of a waveguide to coax adapter was measured by terminating the coax port with a precision coax air line terminated with a reasonably good load and looking into the waveguide port of the adapter. Time domain gating was used to examine only the response of the adapter.

Waveguide to Coax Adapter

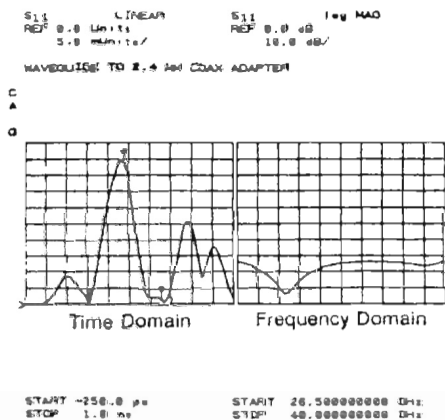

5056

On the left is the reflection coefficient of the waveguide to coax adapter plus the coax load displayed in the time domain. By loosening connections, it was verified that the large response is the waveguide to coax transition. The markers show the location of the time domain gate used to separate this response from the others. On the right is the frequency domain plot of the transition. Using this setup, it was possible to optimize the waveguide to coax transition without interference from the waveguide flange or the fixed termination.

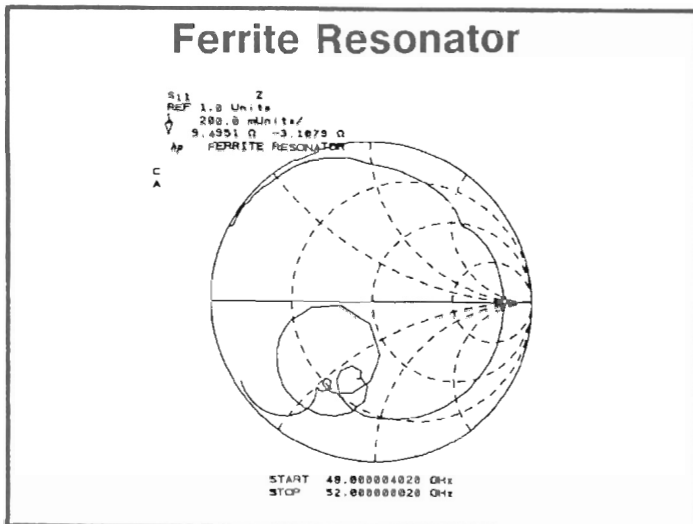

5057

The impedance of a magnetically tunable ferrite resonator is displayed here in Smith chart format. The center of the Smith chart has been normalized to 1 ohm. Several modes are present, but the dominant mode is easily discernible on the Smith chart. In a log magnitude display, the several modes would be difficult to separate. The marker reads out impedance but just as easily could read out real and imaginary, linear magnitude and phase, or log magnitude and phase. A simple frequency response calibration with a short was used.

System Overview
Systematic Errors
Calibration
Non-correctable Errors
System Performance
Measurement Examples
Summary

5058

A high-performance automated millimeter-wave network analyzer has been described. Methods of calibration, calibration standards and the effects of calibration on the measurement of several types of devices were discussed. Typical system performance was measured under various conditions and contributing factors were demonstrated. Finally, several measurements were made on actual devices to provide examples of measurement capability.

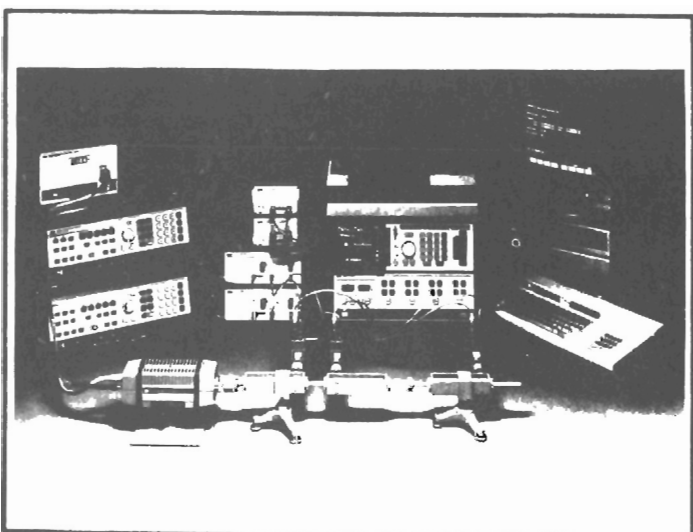

5059

Shown here is a photograph of a system similar to the one on which the work described in this paper was performed.

ACKNOWLEDGMENTS

The following individuals at Hewlett-Packard Network Measurements Division have made technical contributions to these millimeter-wave measurement techniques:

Julius Botka

Jeff Cauffield

Jim Grace

Doug Rytting

I would also like to thank Dr. Roger Pollard of the University of Leeds for his assistance in calibration techniques and software.

REFERENCES

1. Cauffield, Jeff, "Automated Vector Network Analysis at Millimeter-Wave Frequencies", Hewlett-Packard RF and Micro-wave Symposium (1985)
2. Fitzpatrick, Jim, "Error Models for Systems Measurement", Microwave Journal, May 1978.
3. Fitzpatrick, J., "Survey of Millimeter-wave Network Analyzers", 23rd ARFTG Conference Digest (Spring 1984)
4. Hewlett-Packard Co., Product Note 8510-1A
5. Rytting, Doug, "An Analysis of Vector Measurement Accuracy Enhancement Techniques", Hewlett-Packard RF and Microwave Symposium (1980)
6. Rytting, Doug, "Let Time Domain Response Provide Additional Insight into Network Behavior", Hewlett-Packard RF&MW Symposium (1984)

